

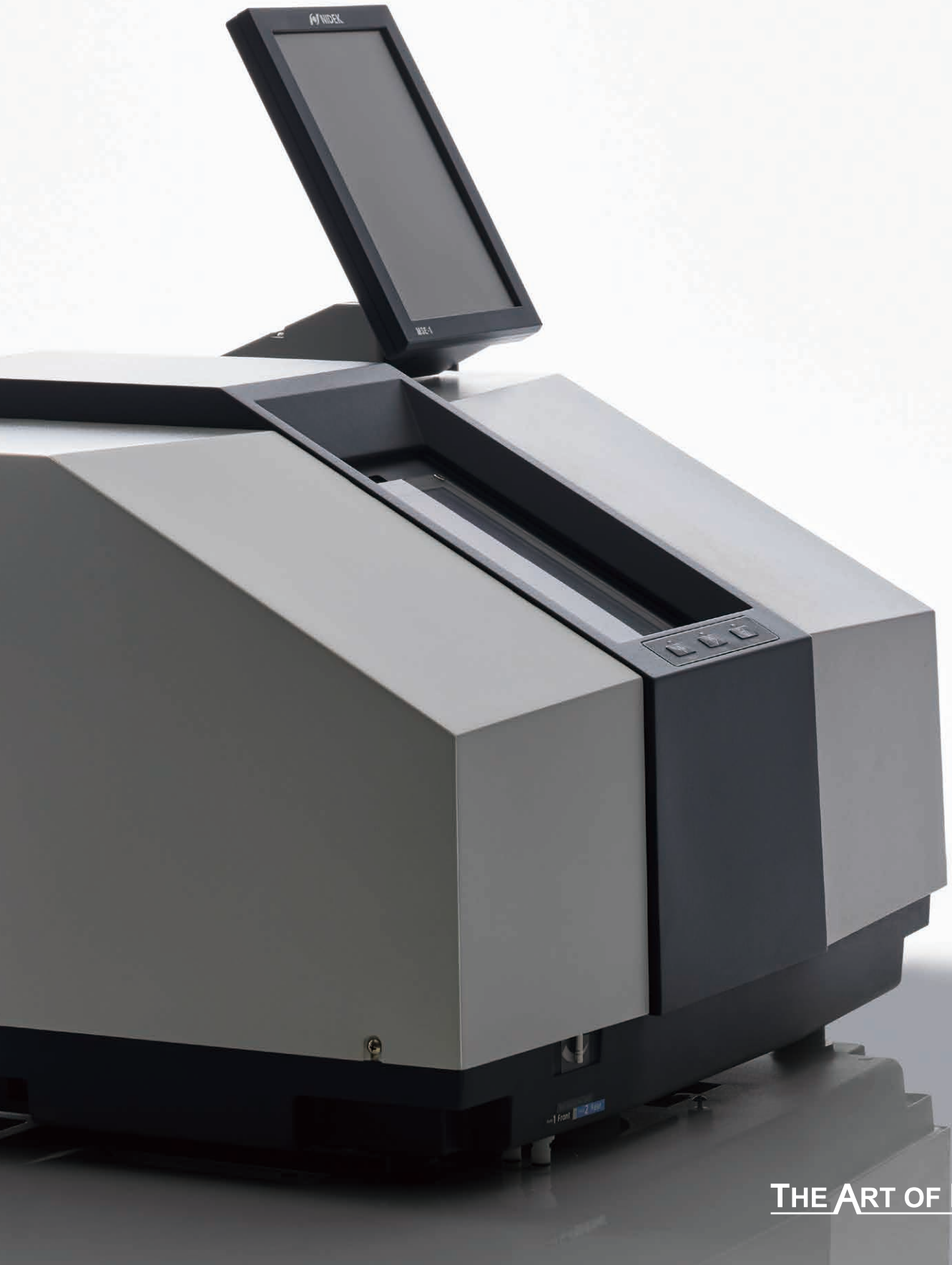

System Edger
MSE-1



THE ART OF EYE CARE

A new chapter with hybrid edging

– Industrial edger performance meets retail edger usability –

The MSE-1 is a next-generation lens edger engineered to deliver the power of an industrial system with the intuitive operation of a retail unit, bridging performance and usability like never before.

Its hybrid edging system pairs a milling tool with grinding wheels for efficient, accurate processing. From high-curve bevels to step bevels, design cuts, and drilling, the MSE-1 handles a wide range of jobs with confidence. A large touchscreen interface and easy-access maintenance features make daily operation intuitive and comfortable.

Designed for versatility and speed, the MSE-1 elevates your edging workflow with power and precision.





Benefits

High-speed and high-accuracy

Extensive edging capabilities

High-performance design for your optimal results

High-speed and high-accuracy



Video of the milling and
wheel processing

Hybrid edging with a milling tool and grinding wheels



Roughing with a milling tool significantly reduces processing time

The MSE-1 features a high-speed spindle custom-engineered for NIDEK, optimized to deliver powerful performance in a compact body. Its rapid rotation enables fast rough cutting, significantly improving lens processing speed.



High-precision finishing achieved with grinding wheels

The MSE-1 delivers high-speed edging without compromising accuracy. Unlike systems that rely solely on a cutter, it uses precision grinding wheels for the finishing process, ensuring consistently accurate results. Backed by NIDEK's proven grinding technology, it offers reliable performance you can count on.

Processing Sequence

An optimized processing sequence and synchronized movements reduce overall edging time, streamlining workflow from start to finish. The MSE-1's advanced control system is designed to boost efficiency for every job.

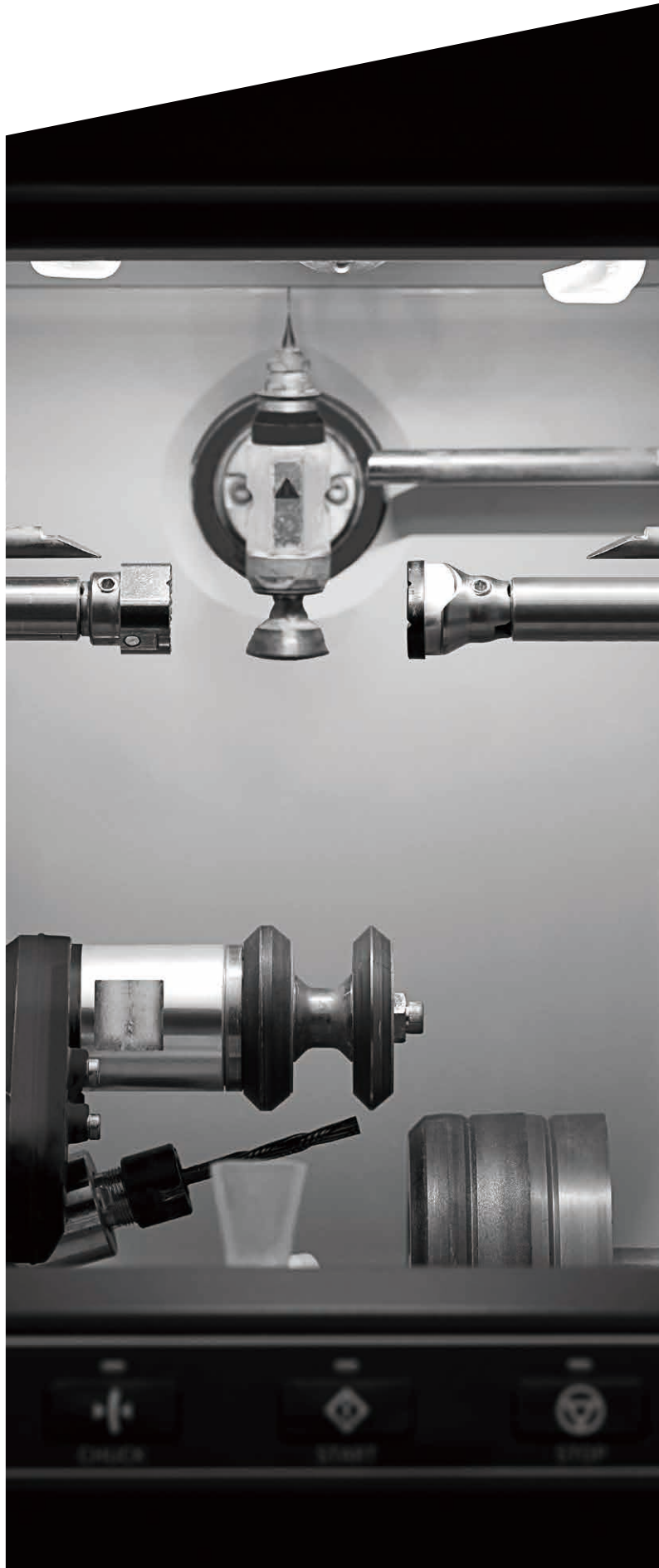



Video of the partial step
beveling and design cut

Extensive edging capabilities

The MSE-1 comes equipped with advanced functions, including high-curve and step beveling, enabling a broad range of lens processing within one compact system. Compatible with various lens materials, it delivers consistently beautiful, high-quality results backed by proven edging technology.



Video of the drilling

Step / partial step beveling

Step beveling makes it easy to fit Rx lenses into sunglass and sport frames. Partial step beveling allows for precise application in designated areas, making it ideal for specialty sport frame designs. With support for lens sizes up to $\varnothing 90$ mm and step heights up to 11 mm, the MSE-1 handles even the most demanding bevel requirements with ease. To further enhance precision, the MSE-1 features variable step angle control, which maintains a uniform step width across the entire lens shape. This prevents the base of the step from becoming thinner, which leads to a consistent accurate fit, even in complex frame geometries, delivering professional-grade results with every lens.

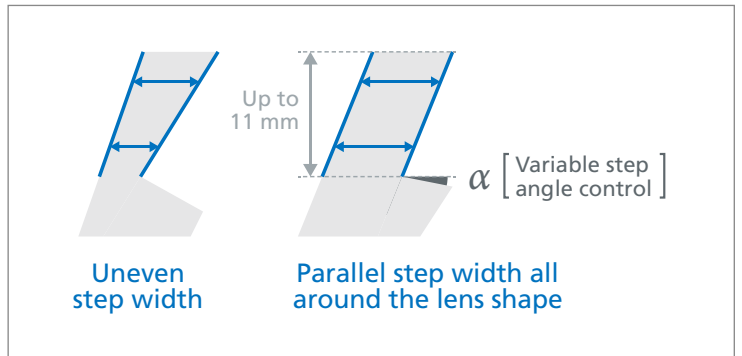
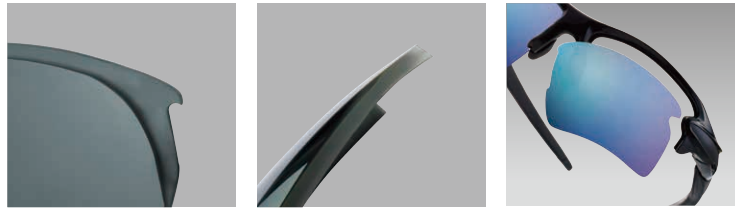

High base curve beveling

NIDEK's unique front and rear independent grinding function offers a high base curve bevel with flawless results. The position and height of the bevel can also be manually controlled.

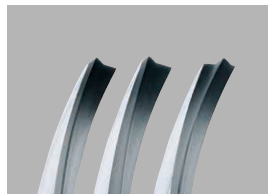

Custom beveling

Trapezoidal beveling enhances both the appearance and fit of lenses, particularly in sport and specialty frames. The heights of the front and rear bevels, along with the width of the bevel apex, can be precisely adjusted for optimal results.



Design cut

The MSE-1 supports the processing of creatively designed lenses, including complex designs such as hook-shaped sports sunglass lenses, expanding what's possible in lens finishing.



Automatic 3D drilling

The MSE-1 supports a wide range of hole shapes, including slots, notches, counterbored, and jewel holes, providing flexibility for detailed, customized lens work.



Mini beveling

Mini beveling is designed for thin-rimmed metal frames, minimizing the visible frosted lens edge that can appear when standard bevels are too large. The result is a cleaner, more refined fit and finish.



Polishing / safety beveling*



*Safety beveling with polish is optional

Grooving

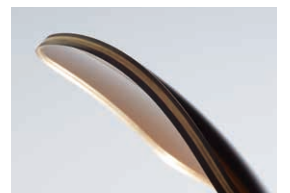

High-performance design for your optimal results

Clear and user-friendly screen

The MSE-1 features a large 10.4-inch color touchscreen that offers excellent visibility and ease of use. The display can be rotated horizontally and tilted to suit your preferred viewing angle. Its clean, retail-inspired interface is designed for intuitive, effortless operation.

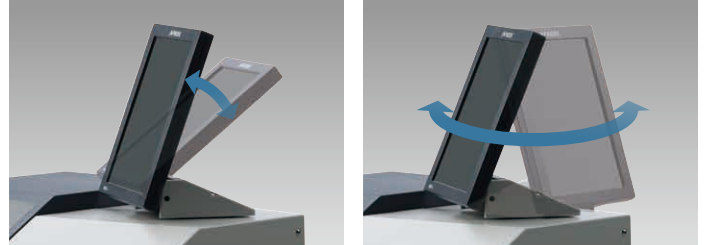

Simulation screen

With bevel and grooving simulation, and shape display from front and side, the optimal condition can be set in order to improve the appearance and right fit of frames.

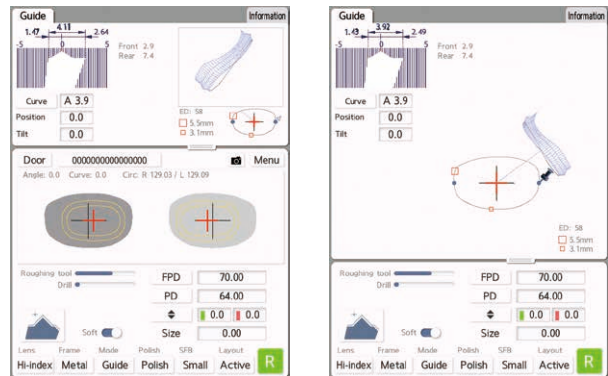

Easy installation

Installation is simplified with a compact air compressor which eliminates the need for bulky compressors or vacuum systems. Its space-saving design makes the MSE-1 ideal for practices with limited space, offering high productivity with a minimal footprint.



Structural robustness and durability

A solid base provides stability for the carriage, high-speed spindle, and milling tool, maintaining precision during operation. The robust design delivers consistent, long-term performance in high-volume settings.

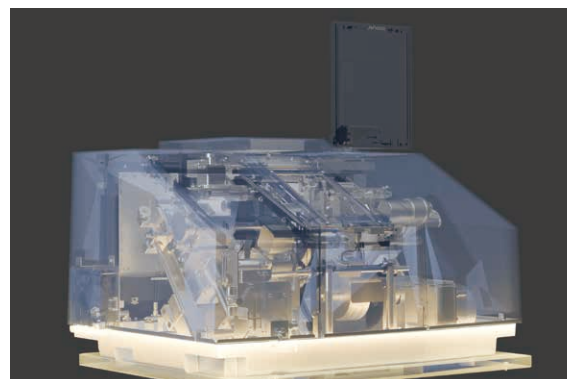

An integrated separator system reduces water consumption

The MSE-1 features a specialized separator that extends water usability and reduces the frequency of water replacement. Fins on the separator capture larger debris from milling tool roughing, directing it into the waste box, while only fine particles flow into the main tank. This keeps the water noticeably clearer than systems using grinding wheels alone, allowing for longer reuse and cleaner operation.

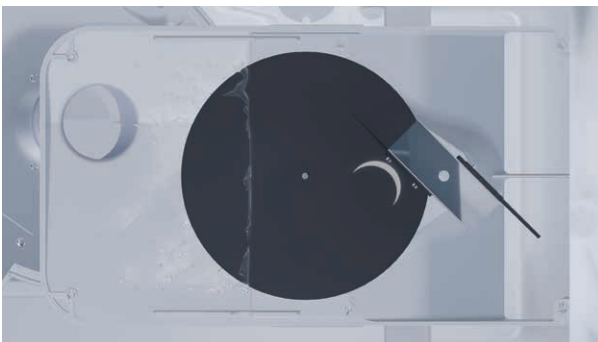

Large debris



Video of the separator function

Clean edging environment

During processing, the MSE-1 uses water to rinse out fine debris and maintain a clean working chamber. The system also rinses the chamber door, helping to remove buildup and simplifying daily maintenance.

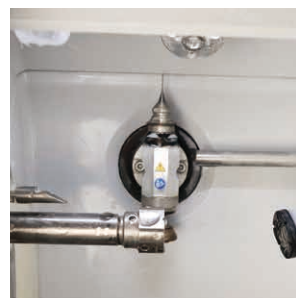

Processing with water



Processing without water

System configurations

Combination with auto blocker with built-in tracer

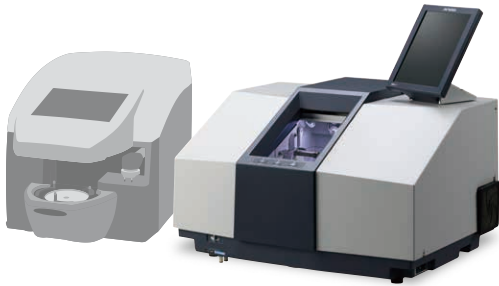

Combination with stand-alone tracer and blocker

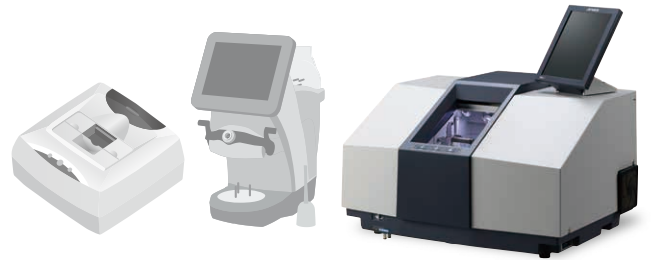

Combination with the Lfu 220 and LED-1

For a cleaner, more comfortable workspace

Pair the MSE-1 with the Lfu 220 lens dust filtration unit to reduce water replacement frequency and improve overall system cleanliness. For added comfort, the LED-1 lens edger deodorizer effectively removes unpleasant odors, helping maintain a fresher working environment.

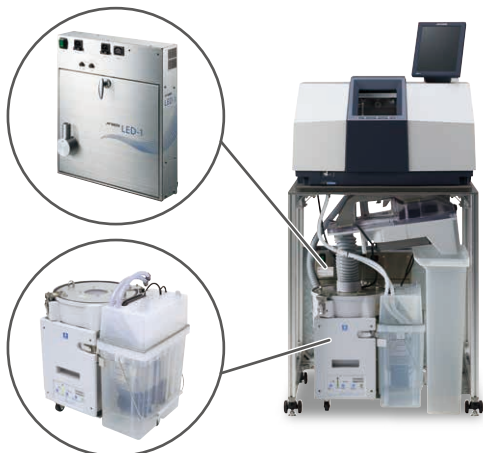

High-volume processing system

For lab environment

The MSE-1 is compatible with VCA protocols, enabling seamless integration into lab workflows. Its ability to operate efficiently across multiple units makes it an ideal choice for high-volume production settings.



Ideal for both labs and retails.
Expand your potential with the MSE-1.



Installation example in a laboratory



Installation example in a retail store

MSE-1 Specifications

Grinding system	Patternless
Mode	Beveling Mini beveling (0.4 to 0.7 mm) (0.1 mm increments) High base curve beveling Custom beveling Step beveling Partial step beveling Flat edging Grooving Polishing Chamfering (polished chamfering is optional) Design cut Drilling Soft processing
Setting range	
FPD	30.00 to 99.50 mm (0.01 mm increments)
PD	30.00 to 99.50 mm (0.01 mm increments)
1/2PD	15.00 to 49.75 mm (0.01 mm increments)
Optical center height	±15.0 mm (0.1 mm increments)
Size adjustment	±9.95 mm (0.01 mm increments)
Minimum grinding size	
Flat edging	ø32.0 x 19.0 mm
Bevel edging	ø33.6 x 20.6 mm
Safety beveling (flat)	ø34.0 x 21.0 mm
Safety beveling (bevel)	ø35.6 x 22.6 mm
High base curve beveling (for a bevel height of 0.8 mm)	ø37.9 x 24.4 mm
Grooving	ø32.0 x 19.0 mm
Drilling	
Hole diameter	ø0.80 to 10.00 mm (0.01 mm increments)
Hole depth	0.1 to 6.0 mm
Minimum lens diameter for drilling	Less than 7°: ø34.0 mm, 7° or larger: ø30.0 mm
Direction for drilling	Automatic/manual tilting 0 to 30°
Water supply system	Pump circulation or direct connection to tap water
Interface	RS-232C - 3 ports LAN - 1 port USB - 1 port
Power supply	100 to 120 V AC / 200 to 240 V AC, 50/60 Hz
Power consumption	1.5 kVA
Air specifications	
Fluid	Dry air
Air pressure	0.3 to 0.35 MPa
Required flow rate	35 L/min
Compressor (Provided by the customer)	Capable of continuous operation (Air flow rate: 70 L/min or higher)
Dimensions/mass	700 (W) x 570 (D) x 670 (H) mm (excluding the separator) 80 kg (including the separator) 27.6 (W) x 22.4 (D) x 26.3 (H)" / 176 lbs.
Standard accessories	Dressing stick for finishing wheel, Compound kit for polishing wheel, Calibration jig, Stylus pen, Wrench, Spindle spanner, Flat lens, Hexagon screwdriver, Drill bit, Roughing tool, Replacing jig for roughing tool, Pliable cup, Pliable cup for high base curve lenses, Pliable cup remover, Double-coated adhesive pad, Wire band, Accessory case, Ferrite core, Acoustic mat, Extension cable (2 units), Power cord
Optional accessories	Barcode scanner, Circular pump tank, USB flash drive, Table for MSE-1, Safety bevel polishing wheel, Regulator set, WECO lens adapter, Drill bit (ø1.0, 1.2, 1.6)



Exclusive distributor and service partner:
Exclusief distributeur en servicepartner:
Distributeur exclusif et partenaire de service :
Exklusiver Vertriebspartner und Servicepartner:



Van Hopplynus
Ophtalm



ARSEUS MEDICAL GROUP

vho.be

E: info@vho.be - T +32 3 830 73 00
Arseus Medical Group nv - Rijksweg 10 - 2880 Bornem

Specifications and design are subject to change without notice.